

Data Sheet



Article number: 03553100

Description: Fluro hydraulic rod end FPR 100U

Measures

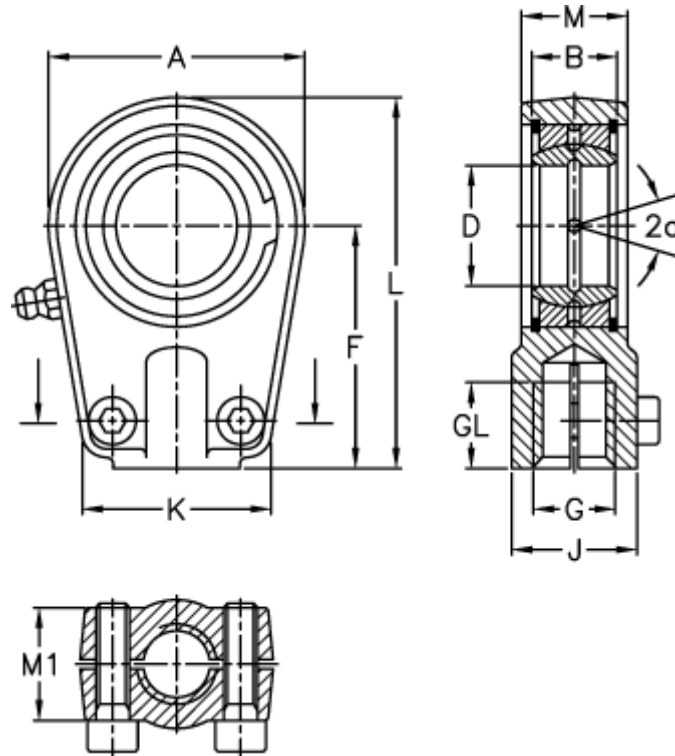

A	= 231	J	= 138
a (degrees)	= 7	K	= 200
B	= 70	L	= 360.7
D	= 100	M	= 70
Dynamic load C (kN)	= 610	M1	= 65
F	= 235	Static load C0 (kN)	= 1120
g	= M110x2	Torque (N m)	= 710
GL	= 111	Weight	= 26310